

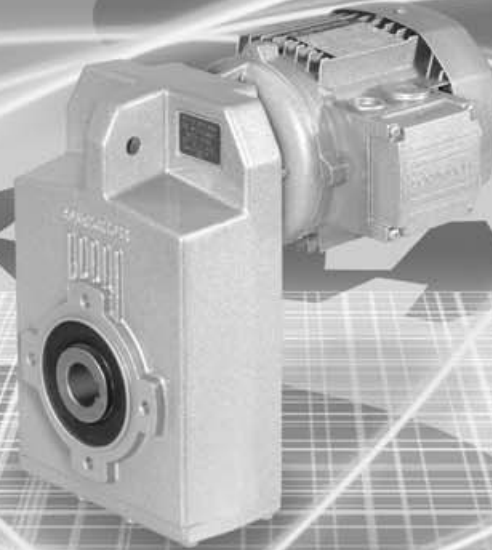













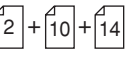

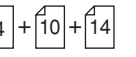

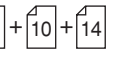



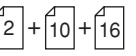

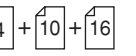

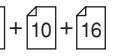













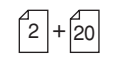

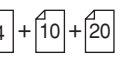

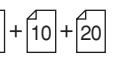



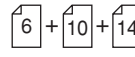

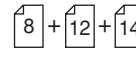
*Lista parti di ricambio - Spare parts list - Ersatzteilliste
Liste des pieces detachees - Lista de partes de recambio*

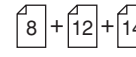
F

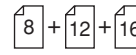



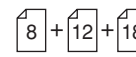

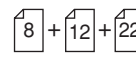
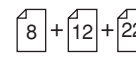
Quadro d'unione delle tavole parti di ricambio
Index of spare parts tables
Inhaltsverzeichnis Ersatzteillisten
Index des tables de pièces de rechange
Índice de la tabla de partes de recambio

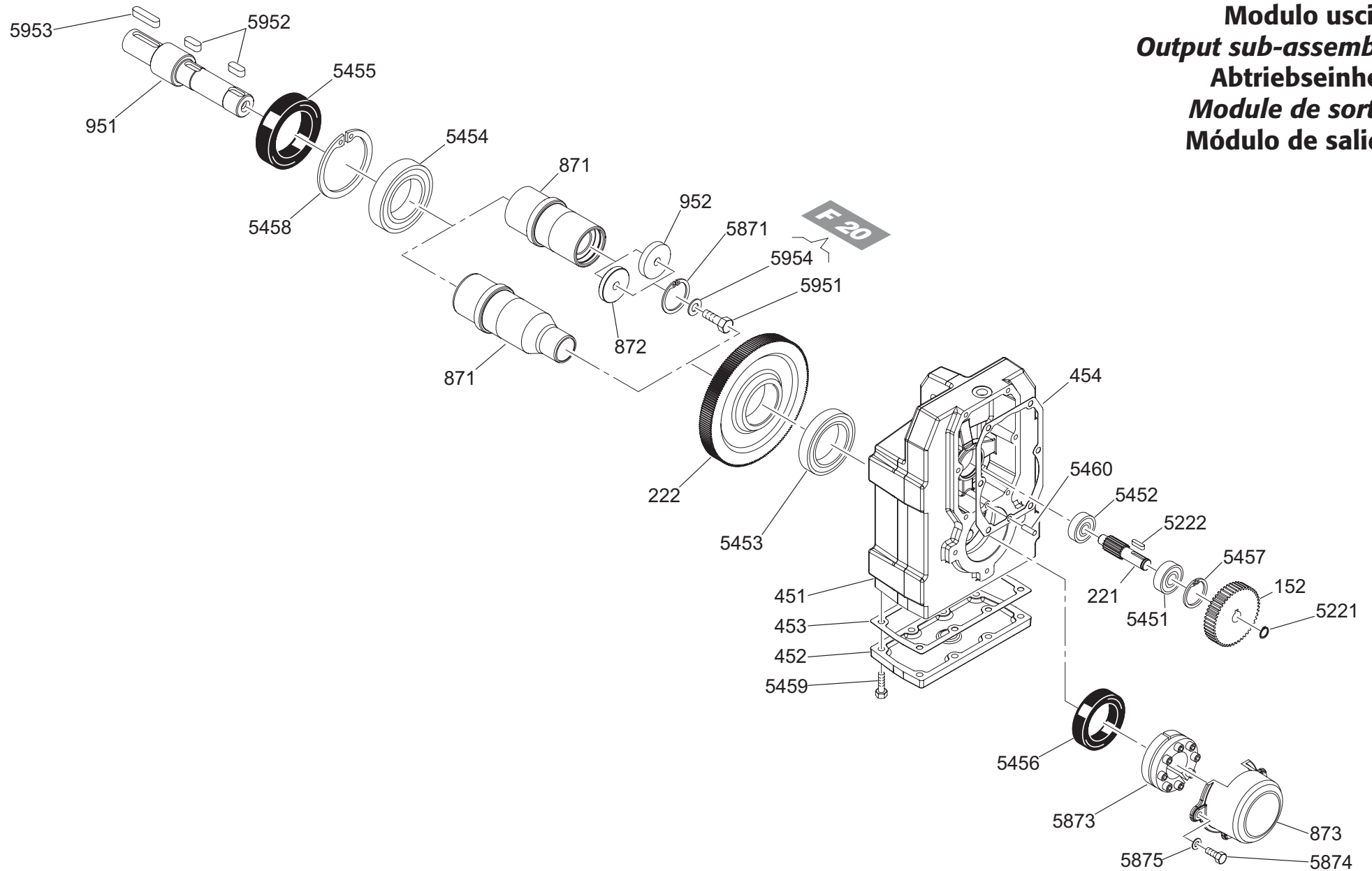



INPUT	F 10 2	F 20 2	F 20 3	F 30 2	F 30 3	F 30 4	F 40 2	F 40 3	F 40 4
 S_									
 P63 ... P132									
 P160 ... P250									
 HS									

INPUT	F 50 2	F 50 3	F 50 4	F 60 3	F 60 4	F 70 3	F 70 4	F 80 3	F 80 4	F 90 3	F 90 4
 S_											
 P63 ... P132											
 P160 ... P250											
 HS											

F 10**F 20**

Pos.	Descrizione	Description	Benennung	Description	Descripción
152	Corona	Housing	Gehäuse	Carter	Caja
221	Pignone	Pinion gear	Ritzel	Pignon	Piñon
222	Corona	Gear	Zahnrad	Couronne	Corona
451	Cassa	Housing	Gehäuse	Carter	Caja
452	Coperchio	Cover	Deckel	Couvercle	Tapa
453	Guarnizione	Gasket	Dichtung	Joint plat	Junta
454	Guarnizione	Gasket	Dichtung	Joint plat	Junta
871	Albero lento	Output shaft	Abtriebswelle	Arbre de sortie	Eje de salida
872	Ralla	Washer	Unterlegscheibe	Rondelle	Arandela
873	Protezione	Safety cover	Schutzvorrichtung	Protection	Protección
951	Albero lento	Output shaft	Abtriebswelle	Arbre de sortie	Eje de salida
952	Ralla	Washer	Unterlegscheibe	Rondelle	Arandela

											
	5451	5452	5453	5454	5457	5458	5871	5221	5222	5952	5953
F 10	6201	6200	61909	6009 6009-2RS WT	32	75	38	12	4x4x16 C	8x7x20 A	8x7x35 A
F 20	6302	6201	6010	6010 6010-2RS WT	42	80	42	15	5x5x17 C	8x7x22 A	8x7x50 A

										
	5460	5455	5456	5873	5459	5478	5874	5951	5875	5954
F 10	ø5x16	45x75x8 DL	45x60x7 DL	19 D30	M6x22	M8x10	M6x16	M8x25	D. 6.4	
F 20	ø5x16	50x80x8 DL	50x65x8 DL	19 D36	M6x22	M8x10 M8x12	M6x16	M10x30	D. 6.4	D. 10.5

F 30



F 40



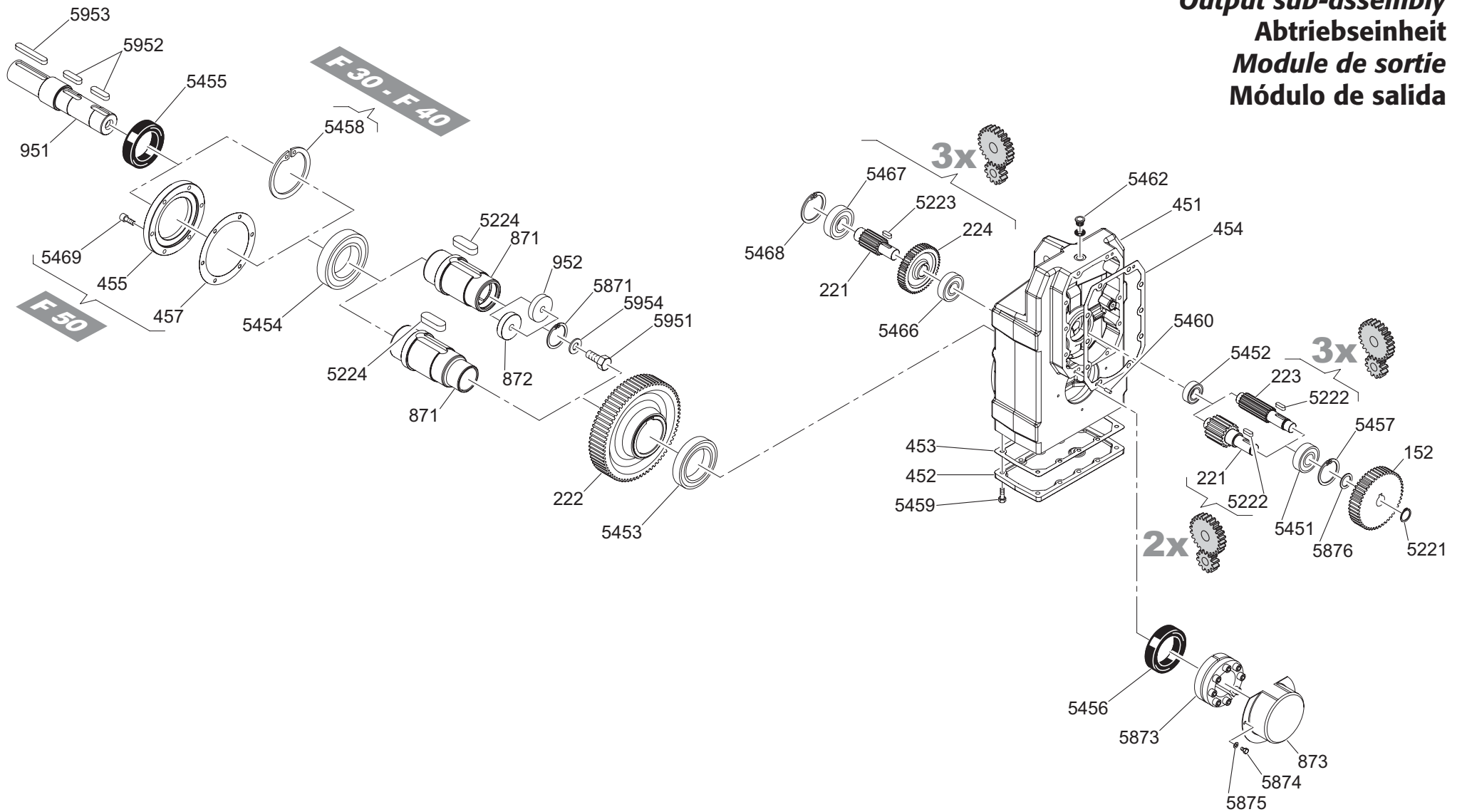

F 50



Modulo uscita
Output sub-assembly
Abtriebseinheit
Module de sortie
Módulo de salida



Pos.	Descrizione	Description	Benennung	Description	Descripción
152	Corona	Housing	Gehäuse	Carter	Caja
221	Pignone	Pinion gear	Ritzel	Pignon	Piñon
222	Corona	Gear	Zahnrad	Couronne	Corona
223	Pignone	Pinion gear	Ritzel	Pignon	Piñon
224	Corona	Gear	Zahnrad	Couronne	Corona
451	Cassa	Housing	Gehäuse	Carter	Caja
452	Coperchio	Cover	Deckel	Couvercle	Tapa
453	Guarnizione	Gasket	Dichtung	Joint plat	Junta
454	Guarnizione cassa	Gasket	Dichtung	Joint plat	Junta
455	Cappello	Cap	Deckel	Capuchon	Sombbrero
457	Guarnizione	Gasket	Dichtung	Joint plat	Junta
871	Albero lento	Output shaft	Abtriebswelle	Arbre de sortie	Eje de salida
872	Rondella	Washer	Unterlegscheibe	Rondelle	Arandela
873	Protezione	Safety cover	Schutzvorrichtung	Protection	Protección
951	Albero lento	Output shaft	Abtriebswelle	Arbre de sortie	Eje de salida
952	Ralla	Washer	Unterlegscheibe	Rondelle	Arandela

											
	5451	5452	5453	5454	5466	5467	5457	5458	5468	5871	5221
F 30 2	30303	30203	6011	6211			42	100		42	17
F 30 3	6303	6203	6011	6211	6302	6303	42	100	47	42	17
F 40 2	30304	32004X	6013	6213			52	120		50	20
F 40 3	6304	6004	6013	6213	6304	6305	52	120	62	50	20
F 50 2	30305	32005X	6015	6215			62			60	25
F 50 3	6305	6005	6015	6215	6305	6306	62		72	60	25





											
	5460	5222	5223	5224	5952	5953	5873	5459	5469	5874	5951
F 30 2	ø6x16	5x5x19 C		18x11x40 B	10x8x30 A	10x8x50 A	TLK600.03 ø44	T.E. M8x30		T.E. M6x10	T.E. M8x30
F 30 3	ø6x16	5x5x19 C	6x6x18 C	18x11x40 B	10x8x30 A	10x8x50 A	TLK600.03 ø44	T.E. M8x30		T.E. M6x10	T.E. M8x30
F 40 2	ø6x16	6x6x25 C		20x12x60 C	12x8x45 A	12x8x70 A	TLK600.03 ø50	T.E. M8x25		T.E. M6x10	T.E. M10x30
F 40 3	ø6x16	6x6x25 C	8x7x22 C	20x12x60 C	12x8x45 A	12x8x70 A	TLK600.03 ø50	T.E. M8x25		T.E. M6x10	T.E. M10x30
F 50 2	ø6x16	8x7x25 C		22x14x65 B	14x9x50 A	14x9x90 A	TLK600.03 ø62	T.E. M8x25	T.C.E.I. M8x22	T.E. M6x10	T.E. M16x40
F 50 3	ø6x16	8x7x25 C	8x7x23 C	22x14x65 B	14x9x50 A	14x9x90 A	TLK600.03 ø62	T.E. M8x25	T.C.E.I. M8x22	T.E. M6x10	T.E. M16x40

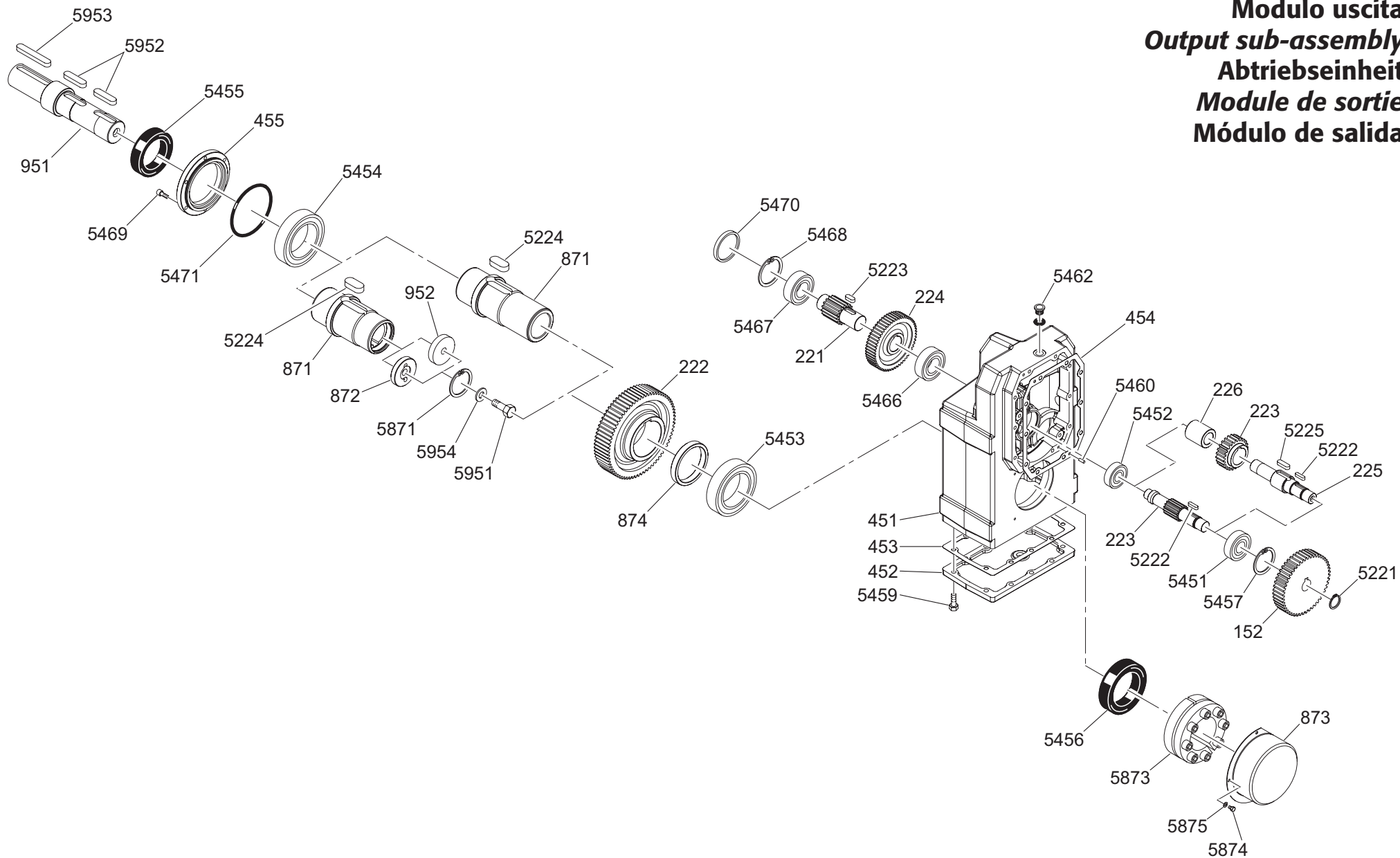





					
	5455	5456	5875	5954	5876
F 30 2	55x100x10 DL	55x72x8 DL	ø6.4	ø8.4	ø17x24x1.5 R
F 30 3	55x100x10 DL	55x72x8 DL	ø6.4	ø8.4	ø17x24x1.5 R
F 40 2	65x120x13 DL	65x85x10 DL	ø6.4	ø10.5	ø20x28x2 R
F 40 3	65x120x13 DL	65x85x10 DL	ø6.4	ø10.5	ø20x28x2 R
F 50 2	75x100x10 DL	75x100x10 DL	ø6.4	ø17	ø25x35x2 R
F 50 3	75x100x10 DL	75x100x10 DL	ø6.4	ø17	ø25x35x2 R

Modulo uscita
Output sub-assembly
Abtriebseinheit
Module de sortie
Módulo de salida

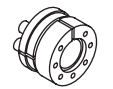

Pos.	Descrizione	Description	Benennung	Description	Descripción
152	Corona	Housing	Gehäuse	Carter	Caja
221	Pignone	Pinion gear	Ritzel	Pignon	Piñon
222	Corona	Gear	Zahnrad	Couronne	Corona
223	Pignone	Pinion gear	Ritzel	Pignon	Piñon
224	Corona	Housing	Gehäuse	Carter	Caja
225	Albero	Shaft	Welle	Arbre	Eje
226	Distanziale	Spacer ring	Distanzring	Entretoise	Distanciador
451	Cassa	Housing	Gehäuse	Carter	Caja
452	Coperchio	Cover	Deckel	Couvercle	Tapa
453	Guarnizione	Gasket	Dichtung	Joint plat	Junta
454	Guarnizione cassa	Gasket	Dichtung	Joint plat	Junta
455	Cappello albero	Shaft holder	Deckel	Capuchon	Sombrero
871	Albero lento	Output shaft	Abtriebswelle	Arbre de sortie	Eje de salida
872	Rondella	Washer	Unterlegscheibe	Rondelle	Arandela
873	Protezione	Safety cover	Schutzvorrichtung	Protection	Protección
874	Distanziale	Spacer ring	Distanzring	Entretoise	Distanciador
951	Albero lento	Output shaft	Abtriebswelle	Arbre de sortie	Eje de salida
952	Ralla	Washer	Unterlegscheibe	Rondelle	Arandela

											
	5451	5452	5453	5454	5466	5467	5457	5468	5871	5221	5460
F 60	30306 32207	30305 32206	32018X	32018X	32208	32208	72	80	75	30	ø6x16

											
	OR 5471	5470	5873	5459	5469	5874	5951	5455	5456	5872	5954
F 60	3525	D80x10	TLK600.03 ø90	T.E. M10x30	T.C.E.I. M8x22	T.E. M6x10	T.E. M16x45	90x110x12 DL	90x130x12 DL	ø 6.4	ø 17

						
	5222	5223	5224	5225	5952	5953
F 60	8x7x30 C	12x8x28 C	25x14x55 B	12x8x38 C	18x11x70 A	18x11x110 A

F 70



F 80

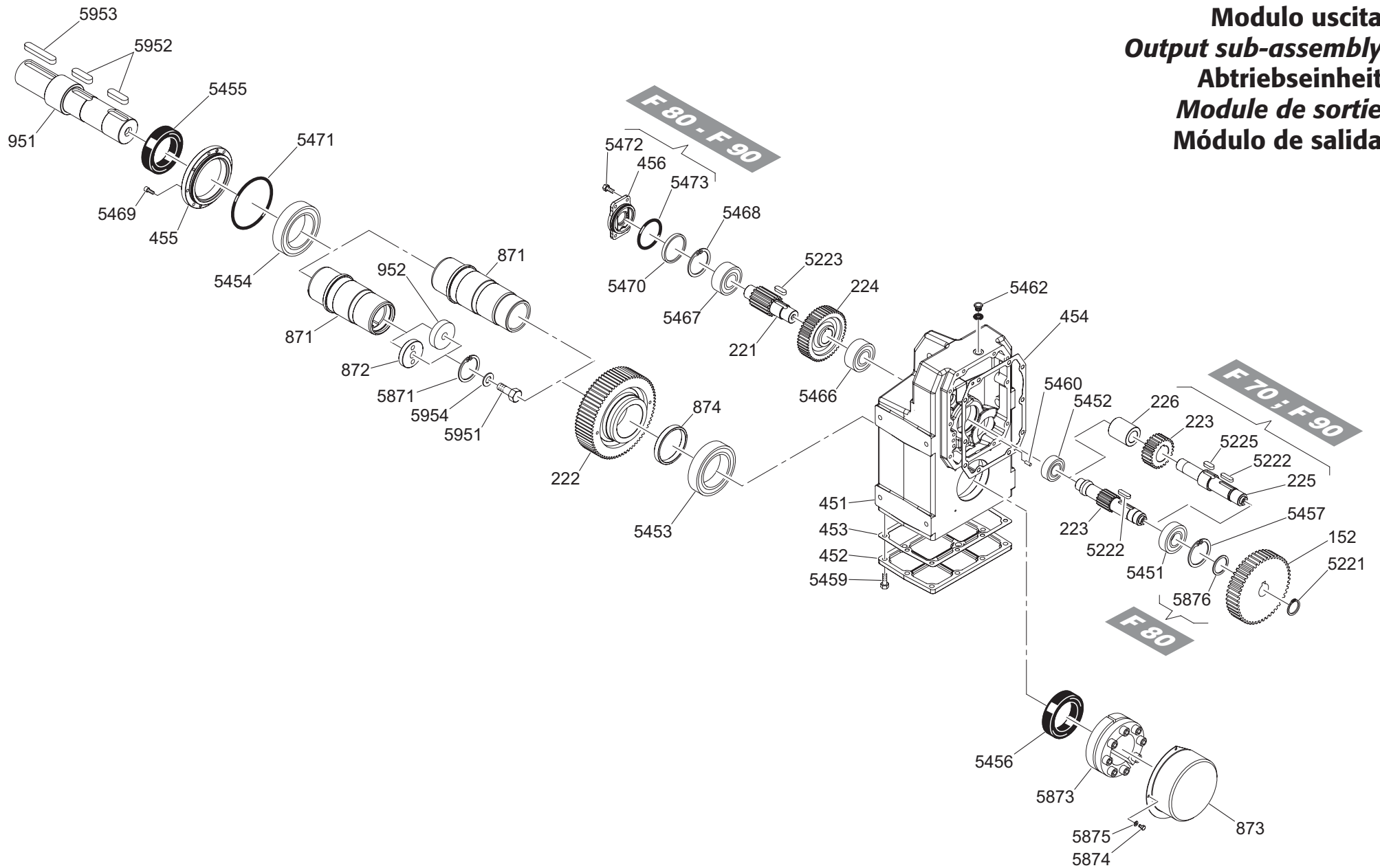



F 90







Modulo uscita
Output sub-assembly
Abtriebseinheit
Module de sortie
Módulo de salida

Pos.	Descrizione	Description	Benennung	Description	Descripción
152	Corona	Housing	Gehäuse	Carter	Caja
221	Pignone	Pinion gear	Ritzel	Pignon	Piñon
222	Corona	Gear	Zahnrad	Couronne	Corona
223	Pignone	Pinion gear	Ritzel	Pignon	Piñon
224	Corona	Gear	Zahnrad	Couronne	Corona
225	Albero lento	Output shaft	Abtriebswelle	Arbre de sortie	Eje de salida
226	Distanziale	Spacer ring	Distanzring	Entretoise	Distanciador
451	Cassa	Housing	Gehäuse	Carter	Caja
452	Coperchio	Cover	Deckel	Couvercle	Tapa
453	Guarnizione	Gasket	Dichtung	Joint plat	Junta
454	Guarnizione	Gasket	Dichtung	Joint plat	Junta
455	Cappello albero	Shaft holder	Deckel	Capuchon	Sombreroete
456	Cappello albero chiuso	Cap	Deckel	Capuchon	Sombreroete
871	Albero lento	Output shaft	Abtriebswelle	Arbre de sortie	Eje de salida
872	Rondella	Washer	Unterlegscheibe	Rondelle	Arandela
873	Protezione	Safety cover	Schutzvorrichtung	Protection	Protección
874	Distanziale	Spacer ring	Distanzring	Entretoise	Distanciador
951	Albero lento	Output shaft	Abtriebswelle	Arbre de sortie	Eje de salida
952	Ralla	Washer	Unterlegscheibe	Rondelle	Arandela

										
	5451	5452	5453	5454	5466	5467	5457	5468	5871	5221
F 70	30308 32308	32207	32021X	32021X	32308	32308	90	90	85	50
F 80	30310 32310	32209	32024X	32024X	32310	32310	110		95	50
F 90	30312 32312	32211 31309	32026X	32026X	32312	32312	130		110	60

								OR		
	5460	5222	5223	5225	5952	5953	5471	5473	5470	5873
F 70	ø8x20	12x8x45 B	19x9x41 C	19x9x36 C	22x14x75 A	22x14x120 A	4600		D90x10	TLK600.03 ø100
F 80	ø8x20	14x9x50 B	16x10x50 C		25x14x100 A	25x14x160 A	4675	4412		TLK600.03 ø110
F 90	ø12x30	18x11x82 C	18x11x60 C	20x12x56 C	28x16x110 A	28x16x190 A	4750	4487		TLK600.03 ø125

										
	5459	5469	5472	5874	5951	5876	5455	5456	5875	5954
F 70	T.E. M12x35	T.C.E.I. M8x22		T.E. M6x10	T.E. M20x55		105x130x12 DL	105x130x12 DL	ø6.4	D 21
F 80	T.E. M12x35	T.C.E.I. M10x25	T.C.E.I. M10x25	T.E. M6x10	T.E. M20x55	ø50x62x3 R	120x150x12 DL	120x150x12 DL	ø6.4	D 21
F 90	T.E. M16x45	T.C.E.I. M10x30	T.E. M10x20	T.E. M6x10	T.E. M24x65		130x170x12 DL	130x170x12 DL	ø6.4	D 25

F 20 3

F 30 4

F 20 3





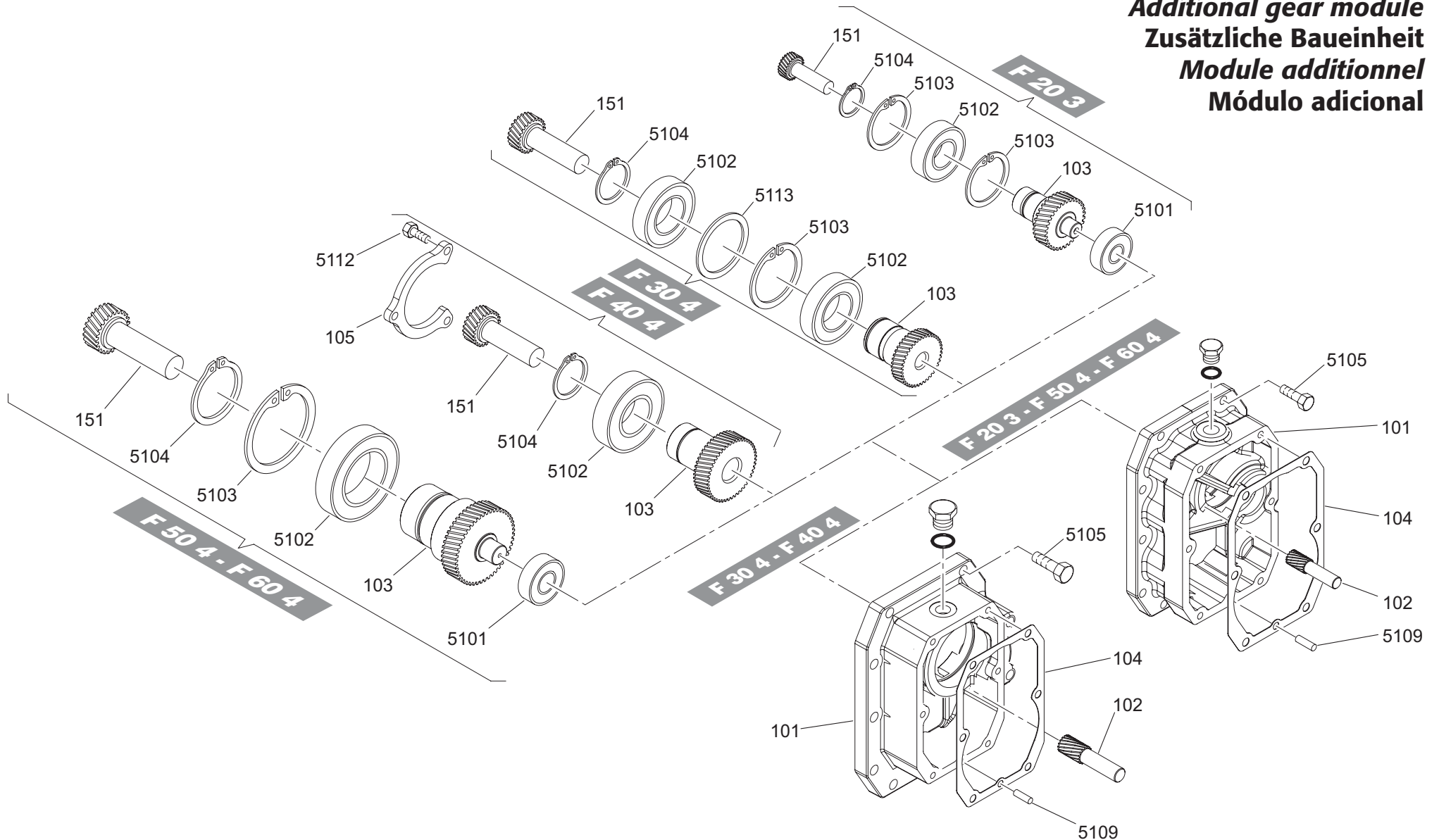

F 50 4

F 60 4

Modulo addizionale
Additional gear module
Zusätzliche Baueinheit
Module additionnel
Módulo adicional







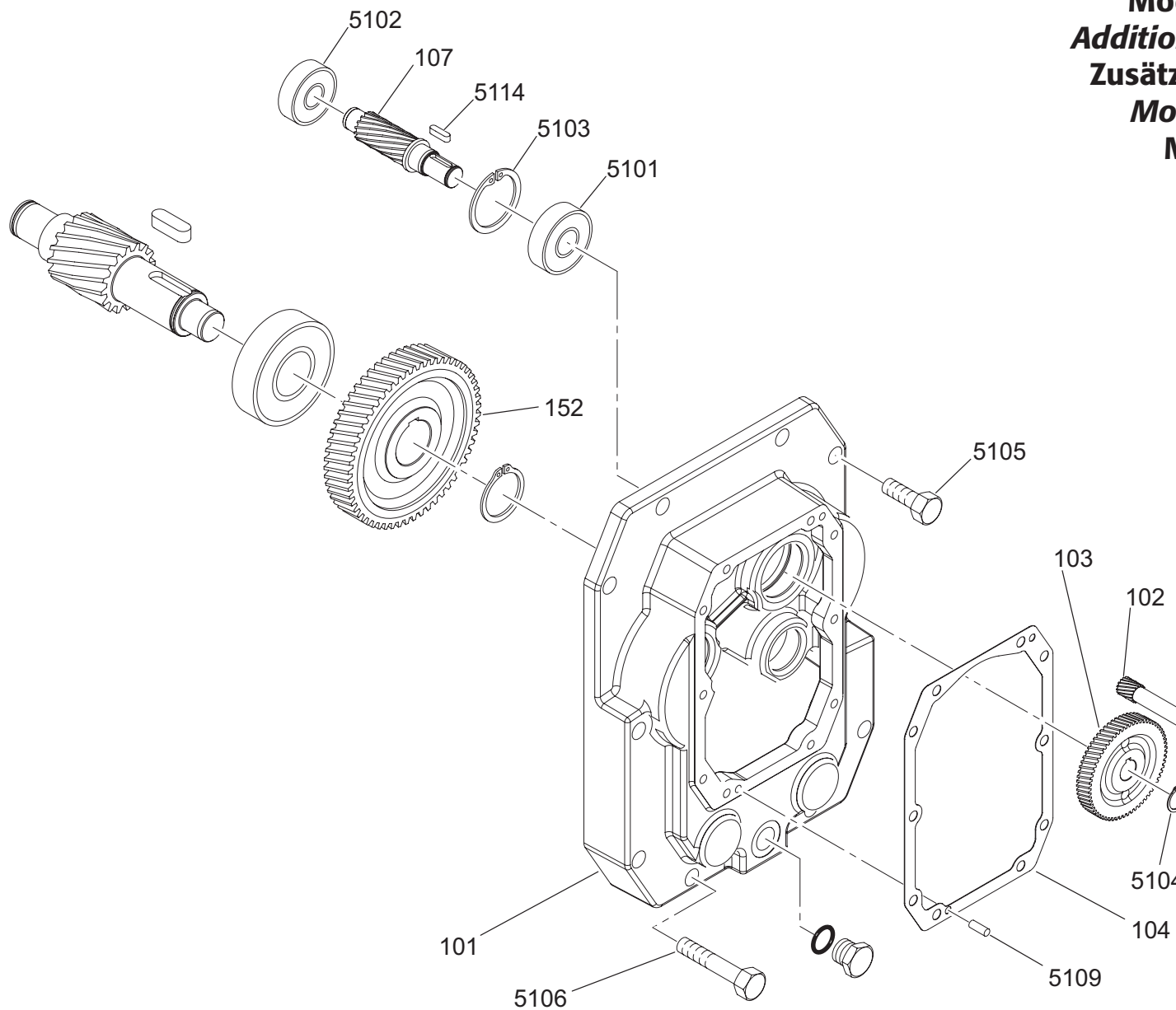

Pos.	Descrizione	Description	Benennung	Description	Descripción
101	Modulo addizionale	Additional gear module	Zusätzliche Baueinheit	Module additionnel	Módulo adicional
102	Pignone	Pinion gear	Ritzel	Pignon	Piñon
103	Corona	Gear	Zahnrad	Couronne	Corona
104	Guarnizione	Gasket	Dichtung	Jointplat	Junta
105	Anello di battuta per cuscinetto	Bearing retainer	Schlußring	Bague de fermeture	Anillo de tope para rodamiento
151	Pignone	Pinion gear	Ritzel	Pignon	Piñon

								
	5101	5102	5104	5103	5109	5105	5112	5113
F 20 3	6201 2Z	6004	20	42	5x16	T.C.E. M6x20 T.C.E. M6x50		
F 30 4		6006	30	55	5x16	T.C.E. M8x25 T.C.E. M8x60		45x55x2 "R"
F 40 4		3206-2RS	30		5x16	T.E. M8x25 T.E. M8x65	T.E. M6x16	
F 50 4	NJ202	6008	40	68	6x16	T.E. M10x35 T.E. M10x75		
F 60 4	NJ203	6010	50	80	6x16	T.E. M10x35 T.E. M10x80		

Modulo addizionale
Additional gear module
Zusätzliche Baueinheit
Module additionnel
Módulo adicional



Pos.	Descrizione	Description	Benennung	Description	Descripción
101	Modulo addizionale	Additional gear module	Zusätzliche Baueinheit	Module additionnel	Módulo adicional
102	Pignone	Pinion gear	Ritzel	Pignon	Piñon
103	Corona	Gear	Zahnrad	Couronne	Corona
104	Guarnizione	Gasket	Dichtung	Jointplat	Junta
107	Pignone	Pinion gear	Ritzel	Pignon	Piñon
106	Supporto per cuscinetto	Bearing support	Lageraufnahme	Support roulement	Soporte para rodamiento
411	Corona	Gear	Zahnrad	Couronne	Corona

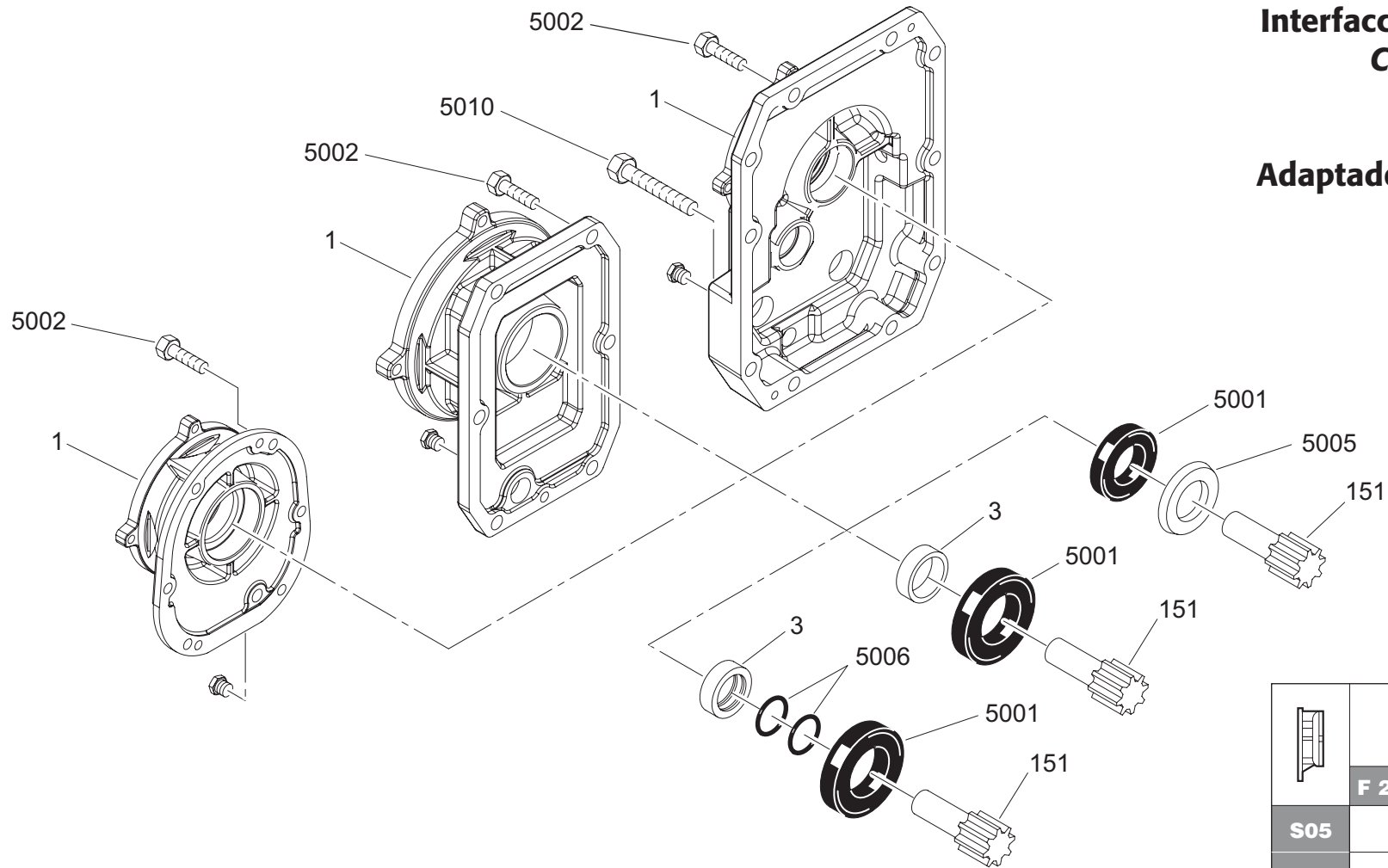

										
	5101	5102	5114	5105	5106	5115	5104	5103	5109	51156
F 70	6304	6303	5x5x19 C	T.E. M12x35	T.E. M12x65	T.C.E.I. M12x30 T.C.E.I. M12x40	17	52	6x16	8x26
F 80	6404	6304	6x6x25 C	T.E. M12x35	T.E. M12x65	T.C.E.I. M12x30	20	72	6x16	8x30
F 90	6306	6305	8x7x25 C	T.E. M16x50	T.E. M16x80	T.C.E.I. M16x35	25	72	6x16	





Interfaccia per motore compatto
Compact motor interface
S Baueinheit
Module S
Adaptador para motor compacto

	OR 5006		
	F 20 - F 30	F 40 - F 50	F 60 ... F 90
S05			
S1			
S2			
S3	4137	4137	4137
S4		149	149
S5			149

Pos.	Descrizione	Description	Benennung	Description	Descripción
1	Coperchio	Cover	Deckel	Couvercle	Tapa
3	Boccola	Bushing	Buchse	Douille	Casquillo
151	Pignone	Pinion gear	Ritzel	Pignon	Piñon



	 5001						 5005				
	F 10	F 20	F 30	F 40 - F 50	F 60 - F 70	F 80 - F 90	F 10 - F 20	F 30	F 40 - F 50	F 60 - F 70	F 80 - F 90
S05	20x35x7 L	20x35x7 L					20x35x4				
S1	20x35x7 L 25x35x7 L	20x35x7 L 25x35x7 L	20x35x7 L 25x35x7 L	20x35x7 L 25x35x7 L			20x35x4	20x35x4	20x35x4		
S2	35x55x8 L	35x55x8 L 42x55x8 L	35x55x8 L 42x55x8 L	35x55x8 L 42x55x8 L	35x55x8 L 42x55x8 L		35x52x4.5	35x52x4.5	35x52x4.5	35x52x4.5	
S3	35x62x7 L	35x62x7 L 48x62x8 L	35x62x7 L 48x62x8 L	35x62x7 L 48x62x8 L	35x62x7 L 48x62x8 L	35x62x7 L 48x62x8 L	35x52x4.5	35x52x4.5	35x52x4.5	35x52x4.5	35x52x4.5
S4				45x85x10 L 65x85x10 L	45x85x10 L 65x85x10 L	45x85x10 L 65x85x10 L			45x62x4.5	45x62x4.5	45x62x4.5
S5					45x85x10 L 65x85x10 L	45x85x10 L 65x85x10 L				45x62x4.5	45x62x4.5

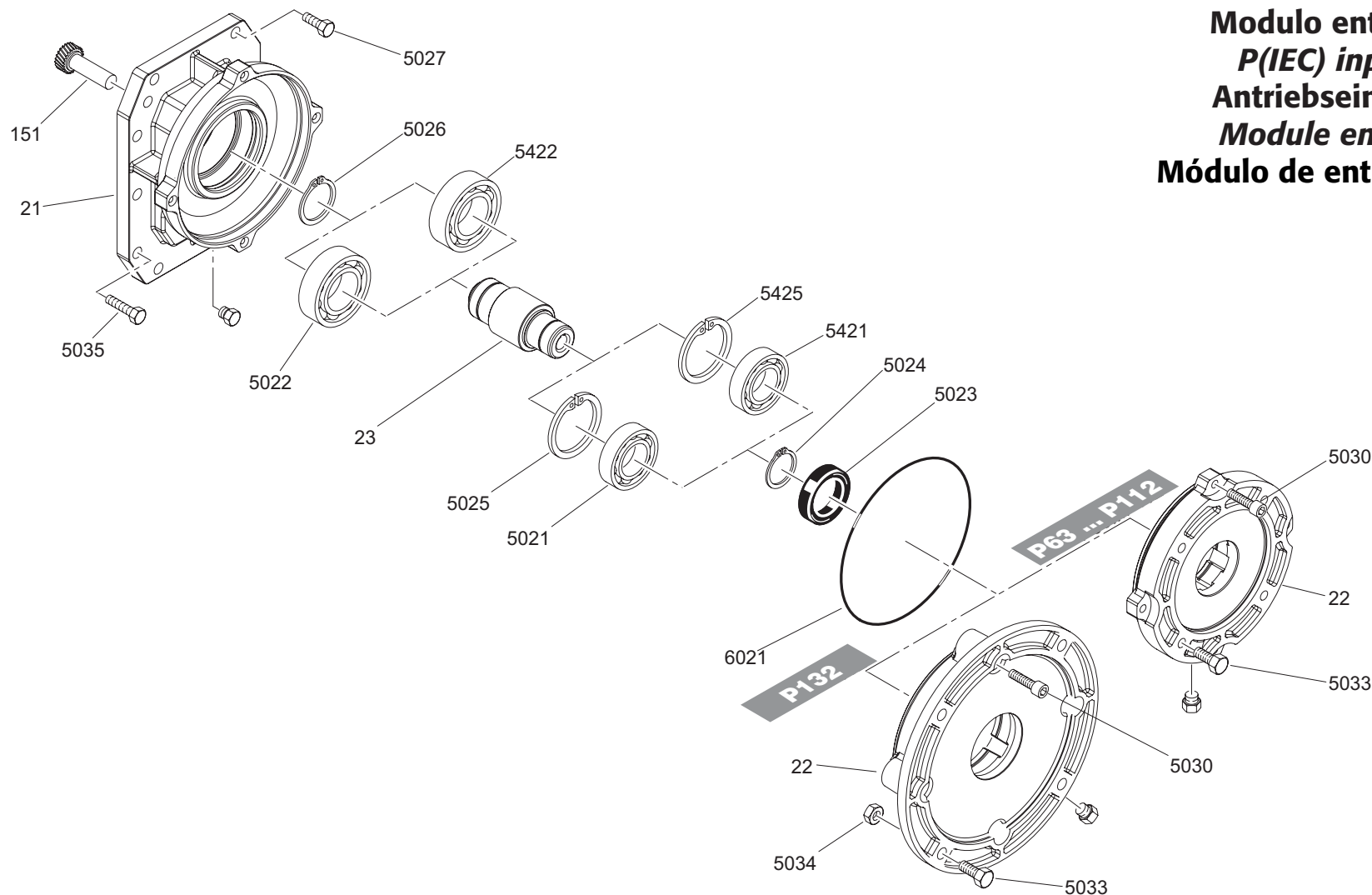



	 5002							 5010				
	F 10	F 20	F 30	F 40	F 50	F 60	F 70	F 80	F 90	F 70	F 80	F 90
S05	M6x18 M6x20 M6x22	M6x20										
S1	M6x20 M6x22	M6x16 M6x18 M6x20 M6x22	M8x25	M8x25	M10x25 M10x30							
S2	M6x20 M6x22	M6x20 M6x22	M8x25	M8x20 M8x25	M10x25 M10x30	M10x30	M12x35			M12x65		
S3	M6x20 M6x22	M6x20 M6x22	M8x25	M8x20 M8x25	M10x25 M10x30	M10x30	M12x35	M12x35	M16x50	M12x65	M12x65	M16x80
S4				M8x20 M8x25	M10x25 M10x30	M10x30	M12x35	M12x35	M16x50	M12x65	M12x65	M16x80
S5						M10x30	M12x35	M12x35	M16x50	M12x65	M12x65	M12x80



Modulo entrata P(IEC)
P(IEC) input module
Antriebseinheit P(IEC)
Module entree P(IEC)
Módulo de entrada P(IEC)

Pos.	Descrizione	Description	Benennung	Description	Descripción
21	Coperchio	Cover	Deckel	Couvercle	Tapa
22	Flangia	Flange	Flansch	Bride	Brida
23	Albero veloce	Input shaft	Antriebswelle	Arbre rapide	eje de salida
151	Pignone	Pinion gear	Ritzel	Pignon	Piñon







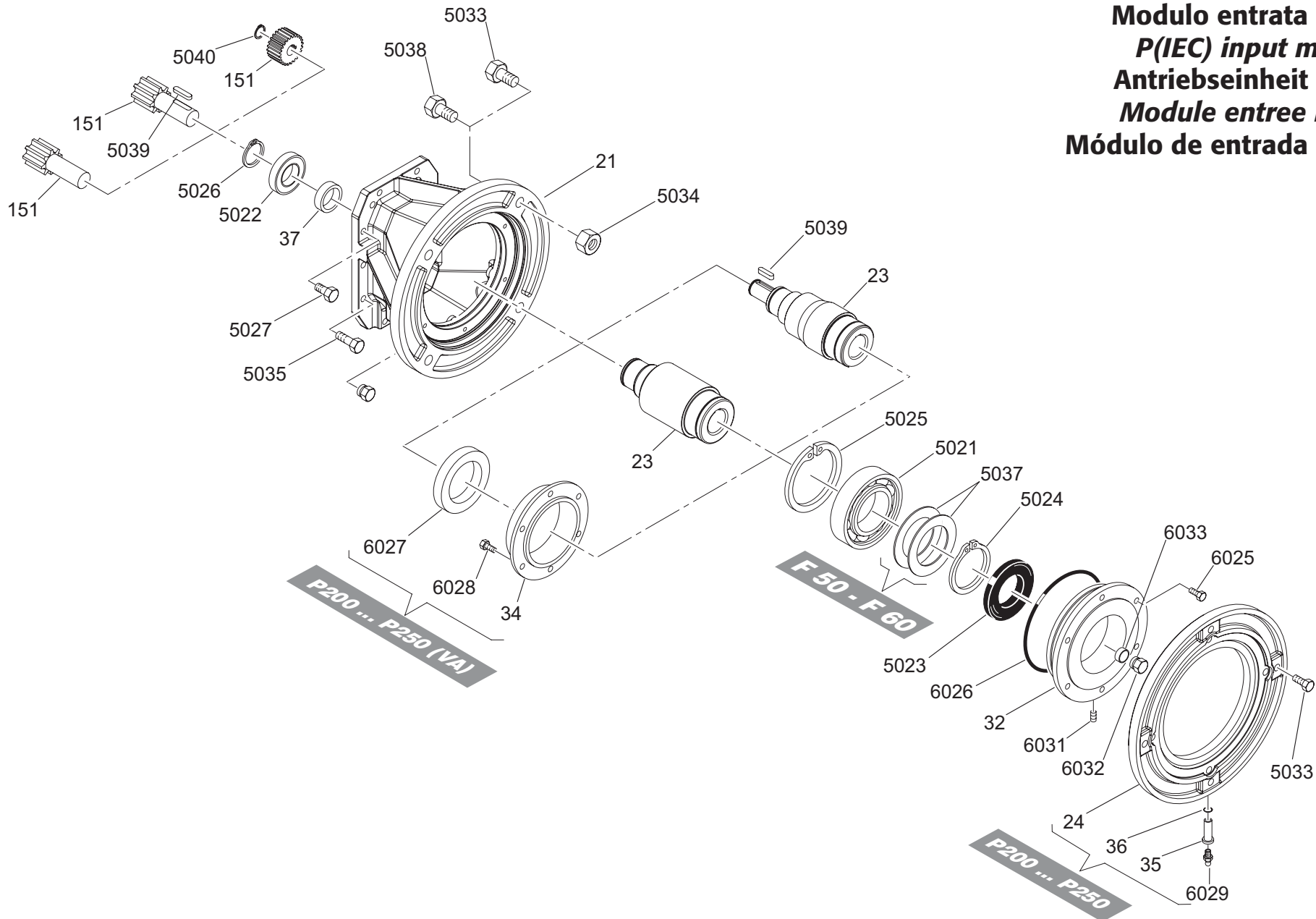



											 OR 6021				 5034			
	5027										5030	5033	5035			6021		5034
	F 10	F 20	F 30	F 40	F 50	F 60	F 70	F 80	F 90			F 70	F 80	F 90	F 10 ... F 30	F 40 ... F 90	F 40 ... F 90	
P63	M6x20	M6x20 M6x22	M8x25	M8x20 M8x25	M10x25 M10x30	M10x30	M12x35			M5x20	M8x20	M12x65			3475	3475		
P71	M6x20 M6x22	M6x20 M6x22	M8x25	M8x20 M8x25	M10x25 M10x30	M10x30	M12x35			M5x20	M8x20	M12x65			3475	3475		
P80	M6x20 M6x22	M6x20 M6x22	M8x25	M8x20 M8x25	M10x25 M10x30	M10x30	M12x35	M12x35	M16x50	M6x25	M10x22	M12x65	M12x65	M16x85	3575	3575		
P90	M6x20 M6x22	M6x20 M6x22	M8x25	M8x20 M8x25	M10x25 M10x30	M10x30	M12x35	M12x35	M16x50	M6x25	M10x22	M12x65	M12x65	M16x85	3575	3575		
P100 P112	M6x20 M6x22	M6x20 M6x22	M8x25	M8x20 M8x25	M10x25 M10x30	M10x30	M12x35	M12x35	M16x50	M6x30	M12x30	M12x65	M12x65	M16x85	3575	3800		
P132				M8x20 M8x25	M10x25 M10x30	M10x30	M12x35	M12x35	M16x50	M8x25	M12x50	M12x65	M12x65	M16x85		3800	M12	



																		
	5023	5021	5022										5421	5422	5024	5026	5025	5425
			F 10	F 20	F 30	F 40	F 50	F 60	F 70	F 80	F 90	F 40 ... F 90					F 40 ... F 90	
P63	25x42x7 L	6005-2RS 6005-2RS WT	6006	6006 6006 2Z 6006-2RS WT	6006	6006	6006	6006	6006					25	30	47		
P71	25x42x7 L	6005-2RS 6005-2RS WT	6006	6006 6006 2Z 6006-2RS WT	6006	6006	6006	6006	6006					25	30	47		
P80	40x62x7 L	6008-2RS 6008-2RS WT	6007 6007 ETN9	6007 6007-2Z 6007-2RS WT 6007 ETN9	6007 6007 ETN9	6007 6007 ETN9	6007 6007 ETN9	6007 6007 ETN9	6007 6007 ETN9	6007 6007 ETN9	6007 6007 ETN9	6007 6007 ETN9		40	35	68		
P90	40x62x7 L	6008-2RS 6008-2RS WT	6007 6007 ETN9	6007 6007-2Z 6007-2RS WT 6007 ETN9	6007 6007 ETN9	6007 6007 ETN9	6007 6007 ETN9	6007 6007 ETN9	6007 6007 ETN9	6007 6007 ETN9	6007 6007 ETN9	6007 6007 ETN9		40	35	68		
P100 P112	45x72x8 L	6009-2RS 6009-2RS WT 6012-2RS	6007 ETN9	6007 ETN9 6007 6007-2Z 6007-2RS WT	6007 ETN9	6209	6209	6209	6209	6209	6209	6209		45	35	75		
P132	55x80x8 L	6012-2RS WT				6209	6209	6209	NJ209E	NJ209E	NJ209E	6012-2RS	6209	60	45	95	95	

Modulo entrata P(IEC)
P(IEC) input module
Antriebseinheit P(IEC)
Module entree P(IEC)
Módulo de entrada P(IEC)



Pos.	Descrizione	Description	Benennung	Description	Descripción
21	Coperchio	Cover	Deckel	Couvercle	Tapa
23	Albero veloce	Input shaft	Antriebswelle	Arbre rapide	eje de salida
32	Cappello per cuscinetto	Bearing holder	Deckel	Capuchon	Sombbrero para rodamiento
37	Distanziale	Spacer ring	Distanzring	Entretoise	Distanciador
151	Pignone	Pinion gear	Ritzel	Pignon	Piñon





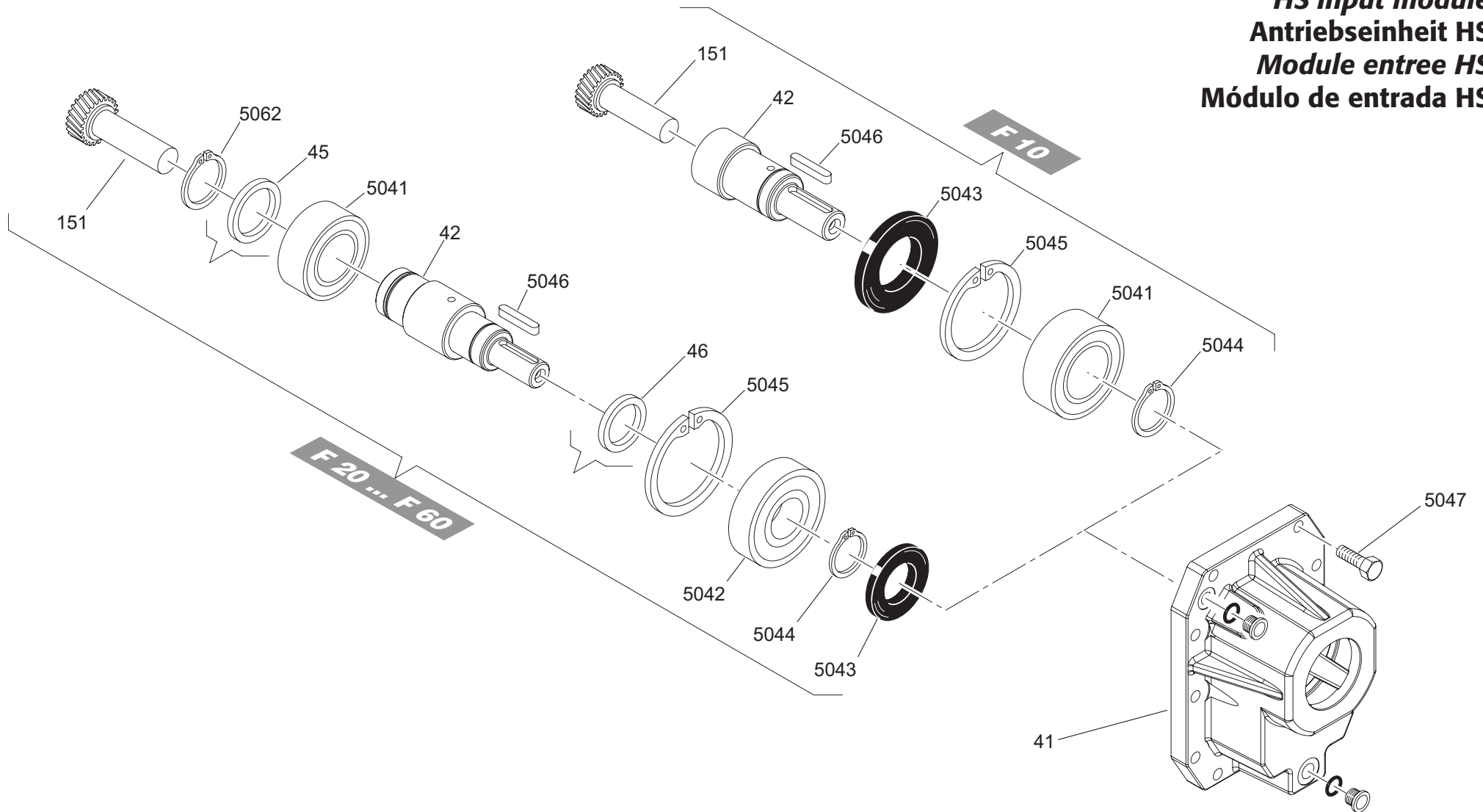

																					
	5021	5022	5039	5024	5026	5040	5025	5037	5034	6029	6031	6033	5023	6027							
							F 50 - F 60		F 80 - F 90		F 80 - F 90		F 80 - F 90		F 50 - F 60		F 70 ... F 90		F 70 ... F 90		
P160	6016 6016 2RS 6216 6216 2RS	NUP210 6210 NUP310 6310	8x7x45 A	80	50	30	125 140	80x100x2 P	M16							80x110x10 L	80x110x10 L				
P180	6016 6016 2RS 6216 6216 2RS	NUP210 NUP310 6310 6212	8x7x45 A 14x9x57 C	80	50 60	30 48	125 140	80x100x2 P	M16							80x110x10 L	80x110x10 L				
P200 ... P250	6216 6216 2RS 3216	6310 NUP310 6212 NUP2212	8x7x45 A 14x9x57 C	80	50 60	30 48	140			M6	M10x14	42x50x1.5					80x110x10 L	90x120x12 L			

															
	5027					5033			5035	6025		5038	6028	OR 6026	
	F 50	F 60	F 70	F 80	F 90	F 50 - F 60	F 70 ... F 90	F 70 ... F 90	F 50 - F 60	F 70 ... F 90	F 70 ... F 90	F 80 - F 90	F 50 - F 60	F 70 ... F 90	
P160	M10x30 M10x35 M10x45	M10x35	M12x40	M12x40	M16x50	M16x60	M16x60	M12x65	M8x25	M8x25				3725	3725
P180	M10x30 M10x35 M10x45	M10x35	M12x40	M12x40	M16x50	M16x60	M16x60	M12x65	M8x25	M8x25				3725	3725
P200 ... P250			M12x40	M12x40	M16x50		M16x35	M12x65		M8x25	M16x40	M6x16			3725

Modulo entrata HS
HS input module
Antriebseinheit HS
Module entree HS
Módulo de entrada HS





Pos.	Descrizione	Description	Benennung	Description	Descripción
41	Coperchio	Cover	Deckel	Couvercle	Tapa
42	Albero veloce	Input shaft	Antriebswelle	Arbre rapide	eje de salida
45	Distanziale	Spacer ring	Distanzring	Entretoise	Distanciador
46	Distanziale	Spacer ring	Distanzring	Entretoise	Distanciador
151	Pignone	Pinion gear	Ritzel	Pignon	Piñon



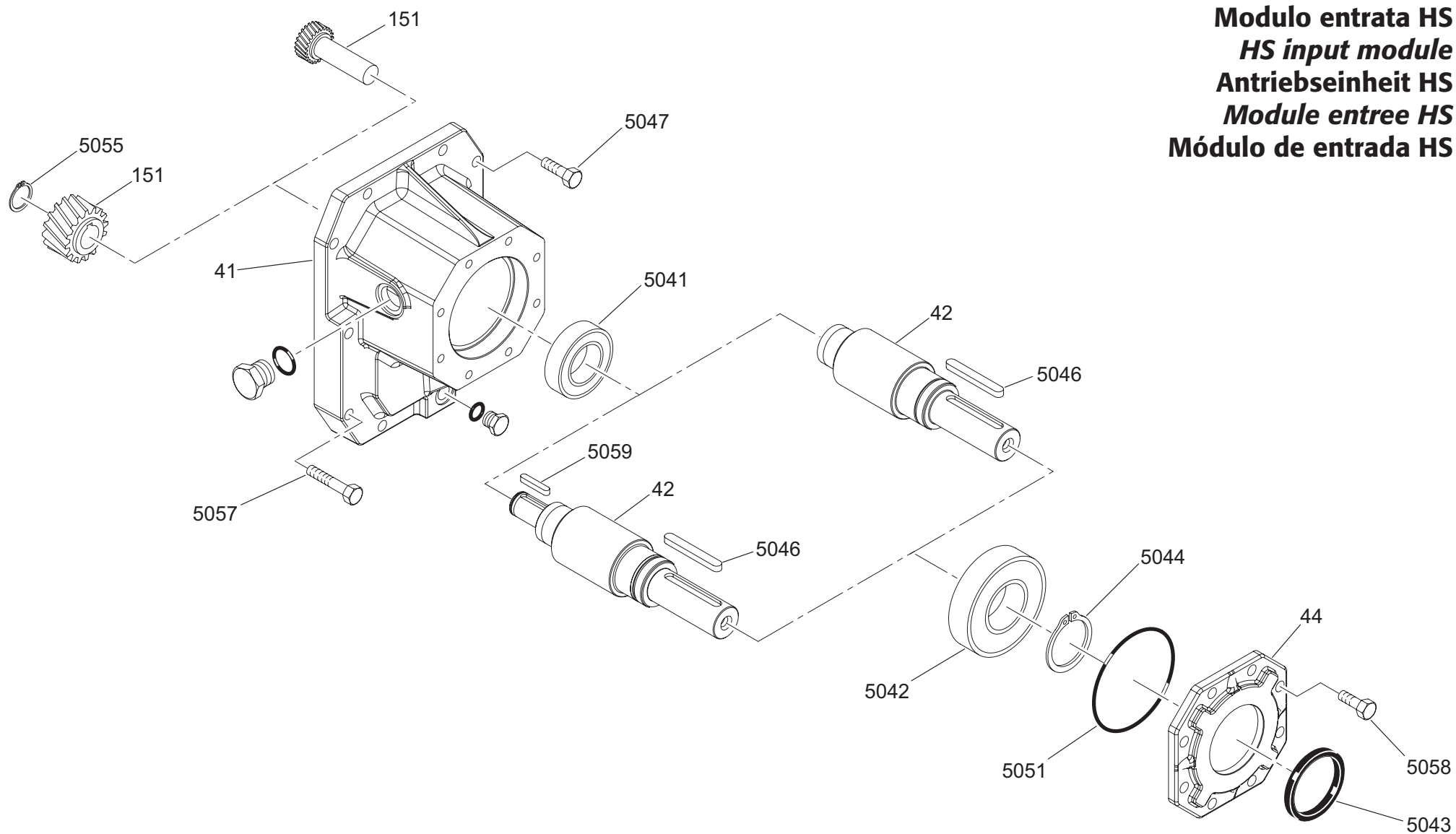

	 5041	5042	 5043	 5046	5044	 5062	 5045	 5047
F 10	3206-2RS		35x62x7 L	5x5x35 A	30		62	T.E. M6x20 T.E. M6x22
F 20	6007	6206-2RS	30x52x7 L	6x6x35 A	30	35	62	T.E. M6x20 T.E. M6x22
F 30	6207	6306-2RS	30x52x7 L	6x6x35 A	30	35	72	T.E. M8x25 T.E. M8x30
F 40	6007	6206-2RS	30x52x7 DL	6x6x35 A	30	35	62	T.E. M8x25 T.E. M6x20
F 50	6210 i = 18.9...21.1 NUP 210 i = 2.6...16.6	6308-2RS	40x62x7 DL	8x7x45 a	40	50	90	T.E. M10x35
F 60	6310	6309-2RS	45x72x8 DL	8x7x50 A	45	50	100	T.E. M10x35

Modulo entrata HS
HS input module
Antriebseinheit HS
Module entree HS
Módulo de entrada HS

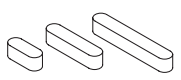
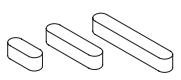

Pos.	Descrizione	Description	Benennung	Description	Descripción
41	Coperchio	Cover	Deckel	Couvercle	Tapa
42	Albero veloce	Input shaft	Antriebswelle	Arbre rapide	eje de salida
44	Cappello per cuscinetto	Bearing holder	Deckel	Capuchon	Sombbrero para rodamiento
151	Pignone	Pinion gear	Ritzel	Pignon	Piñon

 5041			 5042		 5043		 5046		 5059		
F 70	F 80	F 90	F 70 - F 80	F 90	F 70 - F 80	F 90	F 70 - F 80	F 90	F 70	F 80	F 90
NJ2210	NJ310 NJ2212	NJ2214E	6312 6312-2RS 6312-2RS WT	6320 6320-2RS 6320-2RS WT	60x90x8 DL	100x120x12 DL	12x8x90 A	18x11x120 A	8x7x45 A	8x7x45 A 14x9x57 C	14x9x57 C

 5044					 5055			 5047		 5057			 5058	
F 70 - F 80	F 90	F 70	F 80	F 90	F 70 - F 80	F 90	F 70	F 80	F 90	F 70 - F 80	F 90			
60 → 3 ←	100 → 4 ←	30	30 48	48	M12x40	M16x50	M12x65	M12x70	M16x80	M12x30	M16x40			

 OR 5051	
F 70 - F 80	F 90
3500	3850

R0

	Descrizione	Description	Benennung	Description	Descripción

090216

Questa pubblicazione annulla e sostituisce ogni precedente edizione o revisione. Ci riserviamo il diritto di apportare modifiche senza preavviso. È vietata la riproduzione anche parziale senza autorizzazione.

This publication cancels and replaces any previous edition and revision. We reserve the right to implement modifications without notice. This catalogue cannot be reproduced, even partially, without prior consent.

Diese Veröffentlichung annulliert und ersetzt jeder hergehende Edition oder Revision. BONFIGLIOLI behält sich das Recht vor, Änderungen ohne vorherige Informationen durchzuführen.

Cette publication annule et remplace toutes les autres précédentes. Nous nous réservons le droit d'apporter toutes modifications à nos produits. La reproduction et la publication partielle ou totale de ce catalogue est interdite sans autorisation.

Esta publicación anula y sustituye toda anterior edición o revisión. Nos reservamos el derecho de aportar modificaciones sin previo aviso. Se prohíbe la reproducción incluso parcial sin autorización.

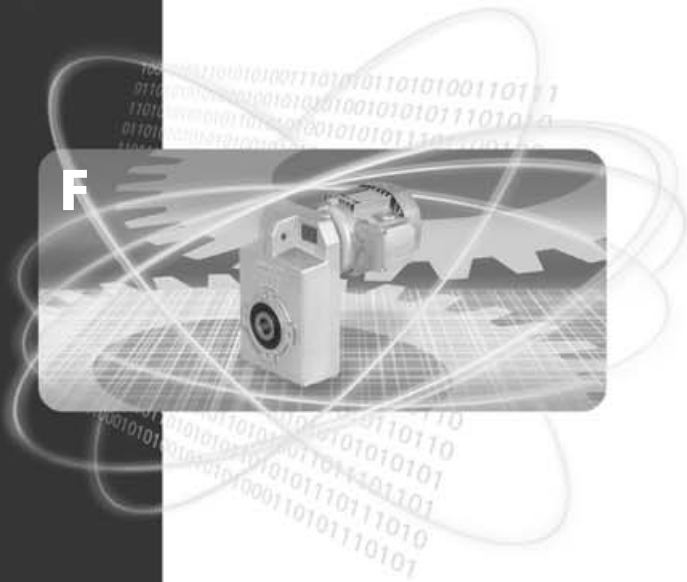

www.bonfiglioli.com

 **BONFIGLIOLI**